

Name of Model		KA-175G	
Dimension (mm)	Width	1,740	
	Length	610	
	Height	384	
Gas Consumption	Naturalgas	41.9 KW	
	LPG	41.9 KW	
Ignition		Piezo spark ignition	
Gas connection (Inside Dia.)	Naturalgas	3/4 elbow	
	LPG	3/4 elbow	
Weight (Kg)		120 Kg	
Clearance from flammable materials (cm)	Around the griller	upper	hood
		side	20
		back	15
		front	_____
Structure of a Floor		Structure of non-combustible	

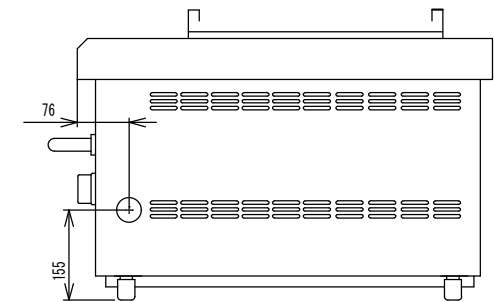
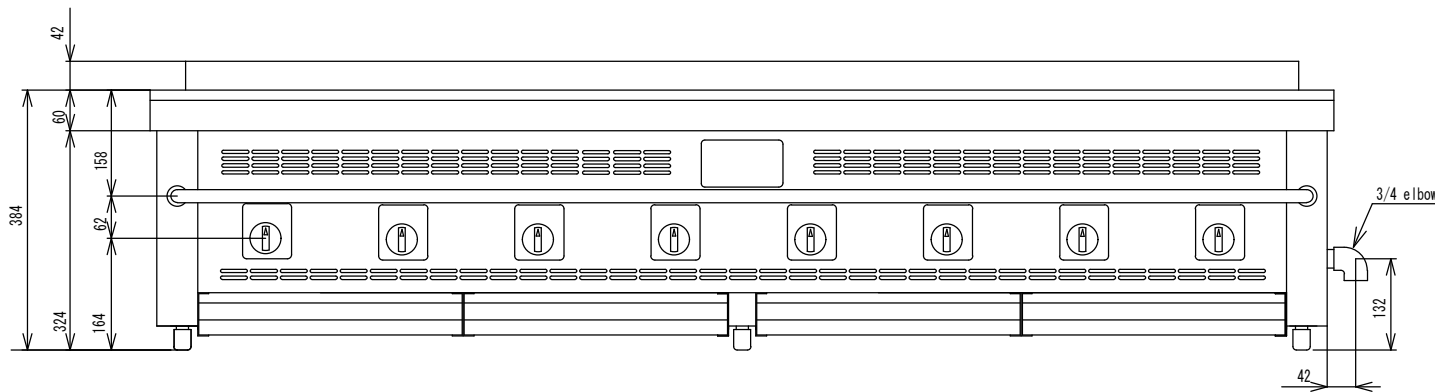
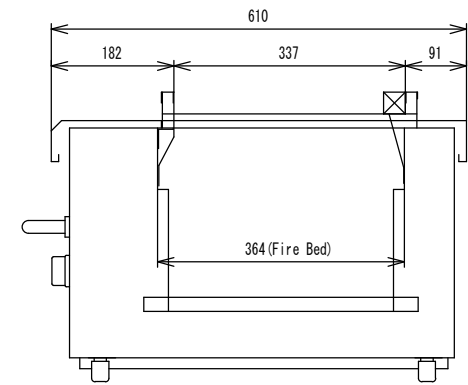

Kosei Kogyou Co.

Name of Product:
Kosei Charcoal Griller

Model
KA-175G type